



JX

Compact and complete

Model: 3G3JX

200 V Class Three-Phase Input 0.2 to 7.5 kW

200 V Class Single-Phase Input 0.2 to 2.2 kW

400 V Class Three-Phase Input 0.4 to 7.5 kW

QUICK START GUIDE



OMRON

Notice:

OMRON products are manufactured for use according to proper procedures by a qualified operator and only for the purposes described in this manual.

The following conventions are used to indicate and classify precautions in this manual. Always heed the information provided with them. Failure to heed precautions can result in injury to people or damage to property.

OMRON Product References

All OMRON products are capitalized in this manual. The word “Unit” is also capitalized when it refers to an OMRON product, regardless of whether or not it appears in the proper name of the product.

© OMRON, 2012

All rights reserved. No part of this publication may be reproduced, stored in a retrieval system, or transmitted, in any form, or by any means, mechanical, electronic, photocopying, recording, or otherwise, without the prior written permission of OMRON.

No patent liability is assumed with respect to the use of the information contained herein. Moreover, because OMRON is constantly striving to improve its high-quality products, the information contained in this manual is subject to change without notice. Every precaution has been taken in the preparation of this manual. Nevertheless, OMRON assumes no responsibility for errors or omissions. Neither is any liability assumed for damages resulting from the use of the information contained in this publication.

JX Quick Start Guide

1 SPECIFICATIONS	3
1.1 Upon receipt	3
1.2 Power ratings.....	3
1.3 Technical specifications	4
2 INSTALLATION.....	5
2.1 Wiring sizes and protection	5
2.2 Installation dimensions.....	5
2.3 Installation environment	6
2.4 Wiring overview.....	7
2.5 Power wiring.....	7
2.6 Control wiring.....	8
2.7 Digital inputs SINK/SOURCE (NPN/PNP) settings	9
3 PROGRAMMING JX	10
3.1 Digital operator	10
3.2 Keypad navigation	11
3.3 Parameter initialization.....	12
3.4 Basic settings	12
3.5 Ramps adjustment	13
3.6 DC injection braking.....	14
3.7 V/F curve.....	15
3.8 Torque boost function	16
3.9 Digital inputs.....	17
3.10 Digital outputs	19
3.11 Analog inputs	19
3.12 Analog output AM terminal.....	20
3.13 Electronic thermal function.....	21
3.14 Carrier frequency.....	22
3.15 PID function.....	22
3.16 Overload limit/warning.....	23
3.17 Overvoltage control function.....	23
3.18 Controlled stop at power loss.....	24
4 PARAMETER LIST	25
4.1 Parameter group D: Monitors	25
4.2 Parameter group A	25
4.3 Parameter group B	27
4.4 Parameter group C	29
4.5 Parameter group H	30
4.6 Parameter group F.....	30

JX Quick Start Guide

1 SPECIFICATIONS

1.1 Upon receipt

Please perform the following task after receiving the drive:

- Inspect the driver for damage. If the drive appear damage upon receipt, contact your supplier.
- Verify the receipt of the correct model by checking the information on the nameplate. If you have received the wrong model contact your supplier.
- Refer to the User's Manual for detailed information about the product and functions.

Basic specifications and optional EMC filter

Voltage	Type	Max Motor (KW)	Rated output current (A)	EMC filter
	3G3JX-			
1 x 200 V	AB002	0.2	1.4	AX-FIJ1006-RE
	AB004	0.4	2.6	
	AB007	0.75	4.0	
	AB015	1.5	7.1	
	AB022	2.2	10.0	
3 x 200 V	A2002	0.2	1.4	AX-FIJ2006-RE
	A2004	0.4	2.6	
	A2007	0.75	4.0	
	A2015	1.5	7.1	AX-FIJ2020-RE
	A2022	2.2	10.0	
	A2037	3.7	15.9	
	A2055	5.5	24.0	
3 x 400 V	A2075	7.5	32.0	AX-FIJ2040-RE
	A4004	0.4	1.5	
	A4007	0.75	2.5	AX-FIJ3005-RE
	A4015	1.5	3.8	
	A4022	2.2	5.5	
	A4040	4.0	8.6	AX-FIJ3011-RE
	A4055	5.5	13.0	
A4075	7.5	16.0	AX-FIJ3020-RE	

1.2 Power ratings

Single-phase 200 V: 3G3JX-		AB002	AB004	AB007	AB015	AB022	-	-	-	
Three-phase 200 V: 3G3JX-		A2002	A2004	A2007	A2015	A2022	A2037	A2055	A2075	
Motor (kW)	Applicable motor capacity	0.2	0.4	0.75	1.5	2.2	3.7	5.5	7.5	
Output characteristics	Inverter capacity (KVA)	200 V	0.4	0.9	1.3	2.4	3.4	5.5	8.3	11.0
		240 V	0.5	1.0	1.6	2.9	4.1	6.6	9.9	13.3
	Rated output current (A)		1.4	2.6	4.0	7.1	10.0	15.9	24.0	32.0
	Max. output voltage		Proportional to input voltage: 0 to 240 V							
Max. output frequency		400 Hz								
Power supply	Rated input voltage and frequency		Single-phase 200 to 240 V 50/60 Hz Three-phase 200 to 240 V 50/60 Hz							
	Rated input current (A) single-phase 200 V		3.1	5.8	9.0	16.0	22.5	-	-	-
	Rated input current (A) three-phase 200 V		1.8	3.4	5.2	9.3	13.0	20.0	30.0	40.0
	Allowable voltage fluctuation		-15% to +10%							
Allowable frequency fluctuation		+5%								
Built-in filter		EMC filter (C1 single phase)								
Braking torque	At short-time deceleration		Approx. 50%			50% for 3-phase	Approx. 20% to 40%		Approx. 20%	
	At capacitor feedback					20 to 40% for 1-phase				
Cooling method		Self cooling			Forced-air-cooling					

SPECIFICATIONS

Three-phase 400 V: 3G3JX-		A4004	A4007	A4015	A4022	A4040	A4055	A4075	
Motor (kW)	Applicable motor capacity	0.4	0.75	1.5	2.2	4.0	5.5	7.5	
Output characteristics	Inverter capacity (KVA)	380 V	0.9	1.6	2.5	3.6	5.6	8.5	10.5
		480 V	1.2	2.0	3.1	4.5	7.1	10.8	13.3
	Rated output current (A)		1.5	2.5	3.8	5.5	8.6	13.0	16.0
	Max. output voltage		Proportional to input voltage: 0 to 480 V						
Max. output frequency		400 Hz							
Power supply	Rated input voltage and frequency		3-phase 380 to 480 V 50/60 Hz						
	Rated input current (A)		2.0	3.3	5.0	7.0	11.0	16.5	20.0
	Allowable voltage fluctuation		-15% to +10%						
	Allowable frequency fluctuation		+5%						
Built-in filter		EMC filter C2 class							
Braking torque	At short-time deceleration	Approx. 50%			Approx. 20% to 40%			Approx. 20%	
	At capacitor feedback								
Cooling method		Self cooling			Forced-air-cooling				

1.3 Technical specifications

Model number 3G3JX-		Specifications
Control functions	Control methods	Phase-to-phase sinusoidal modulation PWM (V/F)
	Output frequency range	0.5 to 400 Hz
	Frequency precision	Digital set value: ±0.01% of the max. frequency
		Analogue set value: ±0.4% of the max. frequency (25 ±10 °C)
	Resolution of frequency set value	Digital set value: 0.1 Hz
	Resolution of output frequency	Analogue set value: 1/1000 of maximum frequency
	Overload capability	150% rated output current for one minute
	Frequency set value	0 to 10 VDC (10 kΩ), 4 to 20 mA (250 Ω), frequency setting volume (selectable), RS485 Modbus
V/f characteristics	Constant/reduced torque	
Functionality	Input signals	FW (forward), RW (reverse), CF1 to CF4 (multi-step speed), JG (jogging), DB (external DC injection braking), SET (2nd function), 2CH (2-step acceleration/deceleration), FRS (free run), EXT (external trip), USP (USP function), SFT (soft lock), AT (analog current input function selection), RS (reset), PTC (thermistor input), STA (3-wire startup), STP (3-wire stop), F/R (3-wire forward/reverse), PID (PID selection), PIDC (PID integral reset), UP (UP of UP/DWN function), DWN (DWN of UP/DWN function), UDC (data clear of UP/DWN function), OPE (forced OPE mode), ADD (frequency addition), F-TM (forced terminal block), RDY (operation ready), SP-SET (special setting), EMR (emergency shutoff)
	Output signals	RUN (signal during operation), FA1 (frequency arrival signal 1), FA2 (frequency arrival signal 2), OL (overload warning signal), OD (PID excess deviation signal), AL (alarm signal), DC (analog input disconnection detection signal), FBV (PID FB status output), NDc (network error), LOG (logical operation result), ODC (communication option disconnected), LOC (light load signal)
	Standard functions	AVR function, V/F characteristics selection, upper/lower limit, 16-step speeds, starting frequency adjustment, jogging operation, carrier frequency adjustment, PID control, frequency jump, analog gain/bias adjustment, S-shape acceleration/deceleration, electronic thermal characteristics/level adjustment, retry function, simplified torque boost, trip monitor, soft lock function, frequency conversion display, USP function, 2nd control function, motor rotation speed UP/DWN, overcurrent suppression function.
	Analogue inputs	2 analogue inputs 0 to 10 V (20 kΩ), 4 to 20 mA (250 Ω)
	Accel/Decel times	0.01 to 3600.0 s (line/curve selection), 2nd accel/decel setting available
	Display	Status indicator LED's Run, Program, Power, Alarm, Hz, Amps, Volume Led indicator Digital operator: Available to monitor frequency reference, output current, output frequency
Protection functions	Motor overload protection	Electronic Thermal overload relay and PTC thermistor input
	Instantaneous overcurrent	180% of rated current
	Overload	150% for 1 minute
	Overvoltage	790 V for 400 V type and 395 V for 200 V type
	Momentary power loss	Following items are selectable: alarm, 0 Hz start, frequency output at interruption, maximum frequency
	Cooling fin overheat	Temperature monitor and error detection
	Stall prevention level	Selectable level applicable only at constant speed or during acceleration and constant speed
	Ground fault	Detected at power-on
Power charge indication	On when power is supplied to the control part	
Ambient conditions	Degree of protection	IP20
	Ambient humidity	90% RH or less (without condensation)
	Storage temperature	-20°C to +65°C (short-term temperature during transportation)
	Ambient temperature	-10°C to 50°C (both the carrier frequency and output current need to be reduced at over 40°C)
	Installation	Indoor (no corrosive gas, dust, etc.)
	Installation height	Max. 1000 m
Vibration	5.9 m/s ² (0.6 G), 10 to 55 Hz (complies with the test method specified in JIS C0040 (1999).)	

2 INSTALLATION

2.1 Wiring sizes and protection

Motor output (kW)	Inverter model 3G3JX-	Wiring	Applicable device	
		Power cable (mm ²)	Earth leakage breaker (ELB)	Fuse size (class J) Rated 600 V
0.2	A2002	1.25	5 A	10 A
0.4	A2004	1.25	5 A	10 A
	A4004			3 A
0.75	A2007	2.0	10 A	15 A
	A4007	1.25	5 A	6 A
1.5	A2015	2.0	15 A	15 A
	A4015	2.0	10 A	10 A
2.2	A2022	2.0	20 A	20 A
	A4022	2.0	10 A	10 A
3.7	A2037	3.5	30 A	30 A
	A4040	2.0	15 A	15 A
5.5	A2055	5.5	50 A	40 A
	A4055	3.5	30 A	20 A
7.5	A2075	8.0	60 A	50 A
	A4075	3.5	30 A	25 A
0.2	AB002	2.0	5 A	14 A
0.4	AB004	2.0	5 A	—
0.75	AB007	2.0	10 A	—
1.5	AB015	5.5	15 A	—
2.2	AB022	5.5	20 A	—

2.2 Installation dimensions

Figure 1

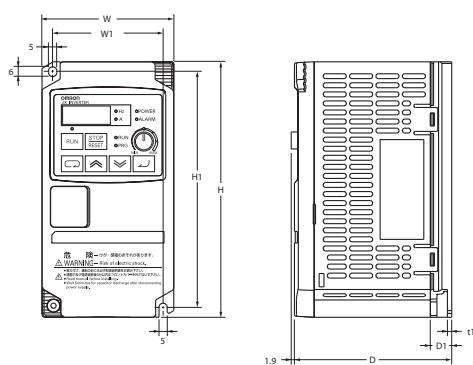
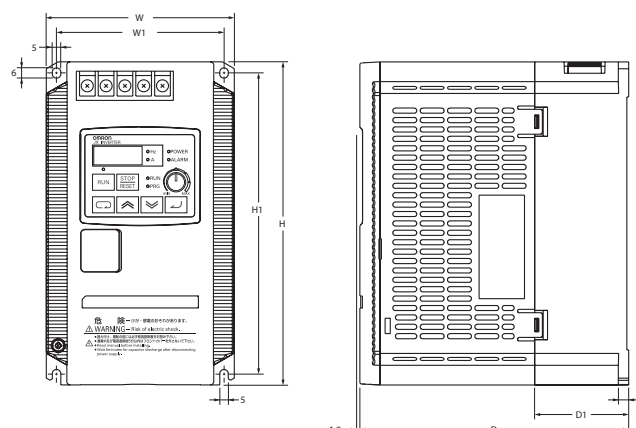

Figure 2



Voltage class	Max. applicable motor output kW	Inverter model 3G3JX-	Figure	Dimensions in mm							
				W1	H1	W	H	D	t1	D1	Weight (kg)
Single-phase 200 V	0.2	AB002	1	67	143	80	155	95.5	2.6	13	0.8
	0.4	AB004						109.5		27	0.9
	0.75	AB007	2	98	176	110	189	130.5	6	28	1.5
	1.5	AB015						157.5		55	2.3
	2.2	AB022						157.5		55	2.4
Three-phase 200 V	0.2	A2002	1	67	143	80	155	95.5	2.6	13	0.8
	0.4	A2004						109.5		27	0.9
	0.75	A2007						132.5		50	1.1
	1.5	A2015	2	98	176	110	189	157.5	6	55	2.2
	2.2	A2022									2.4
	3.7	A2037									2.4
	5.5	A2055									2.4
	7.5	A2075	164	235	180	250	167.5	1.6	77.5	4.2	

INSTALLATION

Voltage class	Max. applicable motor output kW	Inverter model 3G3JX-	Figure	Dimensions in mm							
				W1	H1	W	H	D	t1	D1	Weight (kg)
Three-phase 400 V	0.4	A4004	2	98	176	110	189	130.5	2.6	28	1.5
	0.75	A4007						157.5	6	55	2.3
	1.5	A4015									2.4
	2.2	A4022		164	235	180	250	167.5	1.6	77.5	4.2
	4.0	A4040									
	5.5	A4055									
	7.5	A4075									

2.3 Installation environment

- Increased ambient temperature will shorten the life of the inverter.
- Keep the inverter away from heating elements (such as a braking resistor, DC reactor, etc.). If the inverter is installed in a control panel, keep the ambient temperature within the range of the specifications, taking dimensions and ventilation into consideration.

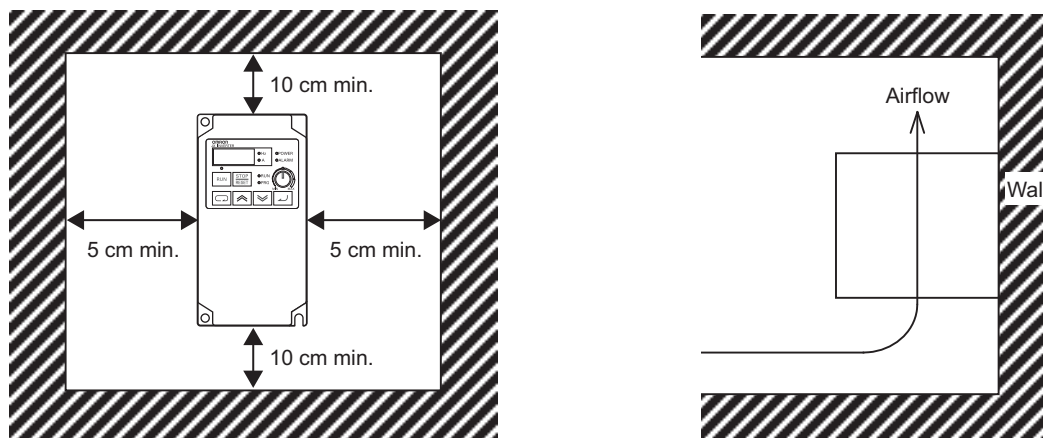

- You can install multiple 3G3JX inverters side by side in the control panel (side-by-side installation). Again, keep the ambient temperature within the specified range (40°C or below).

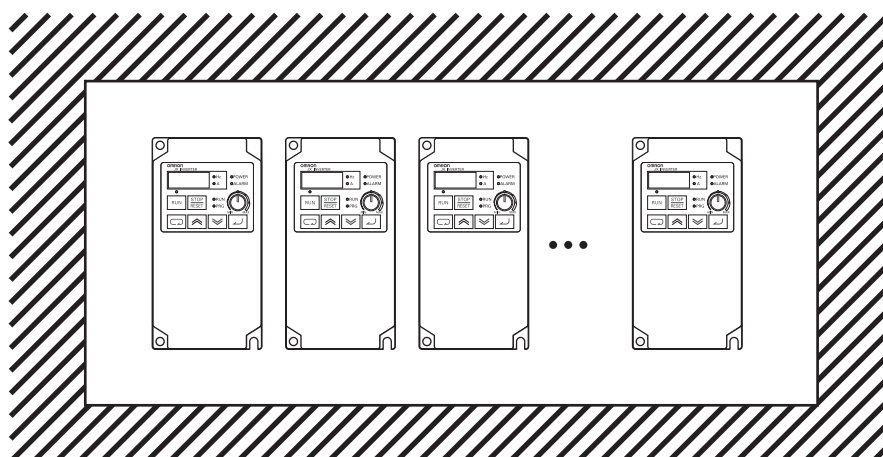

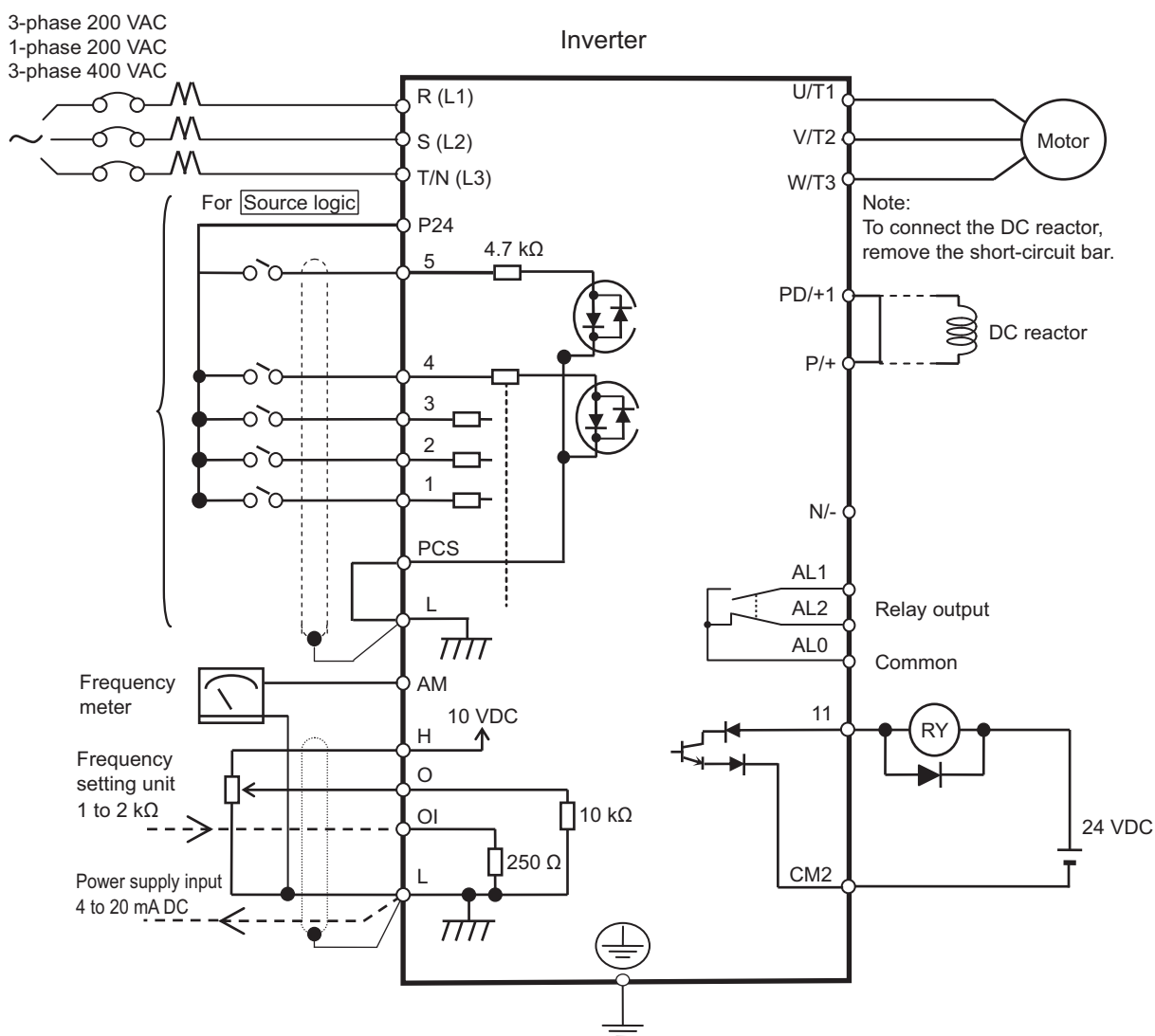

- If the ambient temperature is from 40°C through to 50°C, the carrier frequency should be reduced and the inverter capacity should be increased.

2.4 Wiring overview

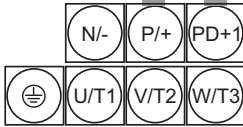
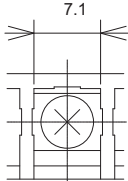

2.5 Power wiring

Terminal name	Purpose	Details
R/L1, S/L2, T/N/L3	Main circuit power supply unit	Used to connect line power to the drive Drives with single-phase 200 V input power use only terminals R/L1 and N (T/L3), terminal S/L2 is not available for these units
U/T1, V/T2, W/T3	Inverter output	Used to connect the motor
PD/+1, P/+	External DC reactor terminal	Normally connected by the short-circuit bar. Remove the short-circuit bar between +1 and P/+2 when a DC reactor is connected
P/+, N/-	Regenerative braking unit connection terminal	Connect optional regenerative braking units (if a braking torque is required)
⏏	Grounding	For grounding (grounding should conform to the local grounding code)

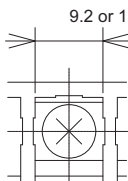
Main circuit terminal block	Model (3G3JX-)	Screw size	W (mm)	
Upper side of the body  Lower side of the body 	AB002 to AB004 A2002 to A2007 *1	M3.5	7.1	 Main Circuit Terminal Block
Upper side of the body  Lower side of the body 	A2015 to A2037 A4004 to A4040 AB007 to AB022 *1	M4	9.2	 Main Circuit Terminal Block
	A2055 to A2075 A4055 to A4075	M5	13	

*1. For 3G3JX-AB, R/L1 corresponds to L1 and T/L3 to N, terminal S/L2 is not available. Connect a single-phase 200 VAC input to terminals L1 and N.

2.6 Control wiring

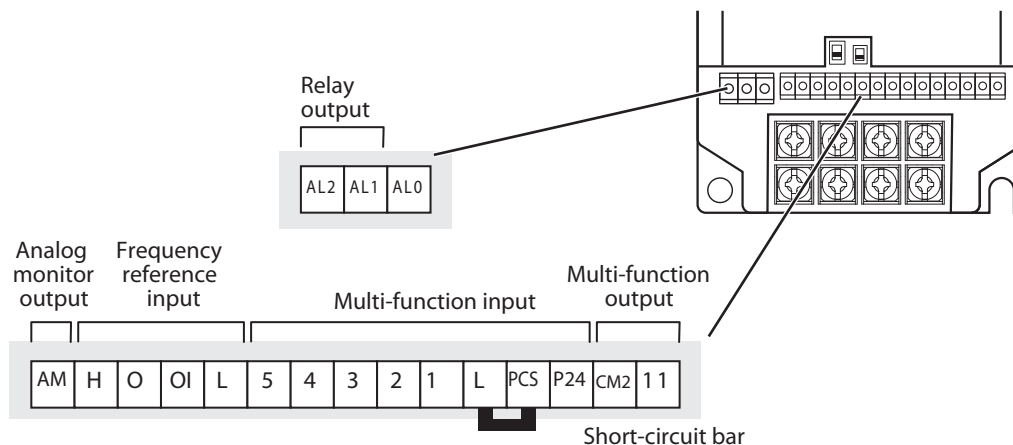

Type	No.	Signal name	Function	Signal level
Digital input signals	PCS	Input power supply	External power supply terminal for input signal (input) ...At sink logic Internal power supply output terminal for input signal (output) ...At source logic	24 VDC ±10%
	P24	Internal 24 VDC	24 VDC internal power supply	24 VDC ±10%, 100 mA
	1	Multi-function input selection 1	Factory setting: Forward/Stop	27 VAC max ON voltage: 18 V min OFF voltage: 3 V max Load current: 5 mA Min ON time: 12 ms
	2	Multi-function input selection 2	Factory setting: Reverse/Stop	
	3	Multi-function input selection 3	Factory setting: Fault reset	
	4	Multi-function input selection 4	Factory setting: Emergency stop fault	
	5	Multi-function input selection 5	Factory setting: Multi-step speed reference 1	
L	Multi-function input selection common	–	–	
Analog input signals	H	Frequency reference power supply	10 VDC 10 mA max	
	O	Voltage frequency reference signal	0 to 10 VDC (10 kΩ)	
	OI	Current frequency reference signal	4 to 20 mA (250 Ω)	
	L	Frequency reference common	–	–

INSTALLATION

Digital output signals	AL2	NC output	Factory default relay settings Under normal operation: AL2-AL0 closed Under abnormal operation: AL1-AL0 open	250 VAC 2.5 A 30 VDC 3 A
	AL1	NO output		250 VAC 1 A 30 VDC 1 A 5 V, 100 mA min
	AL0	Relay output common	Factory setting: Frequency arrival signal at a constant speed	27 VDC 50 mA max
	11	Multi-function output terminal	-	-
	CM2	Output signal common	-	-
Monitor signal	AM	Analog frequency monitor/Analog output current monitor	Factory setting: Analog frequency monitor	0 to 10 VDC, 1 mA



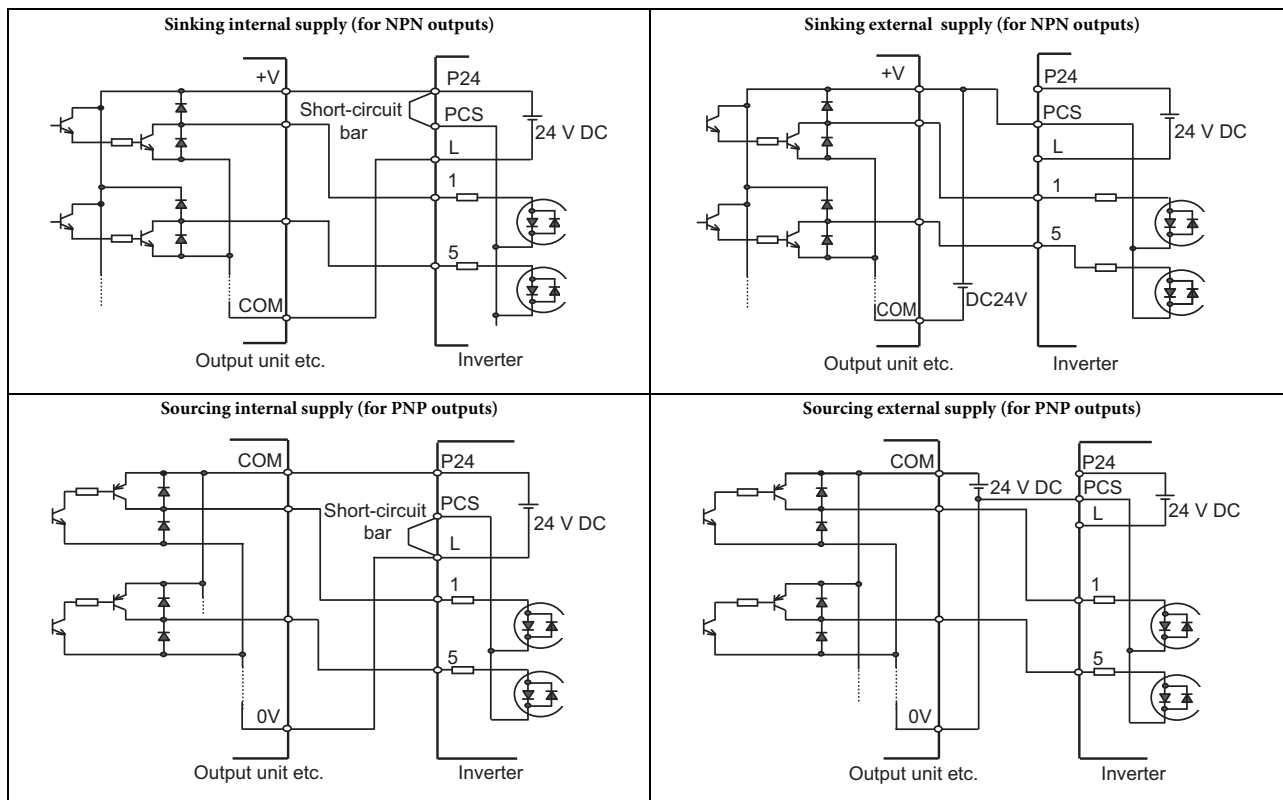



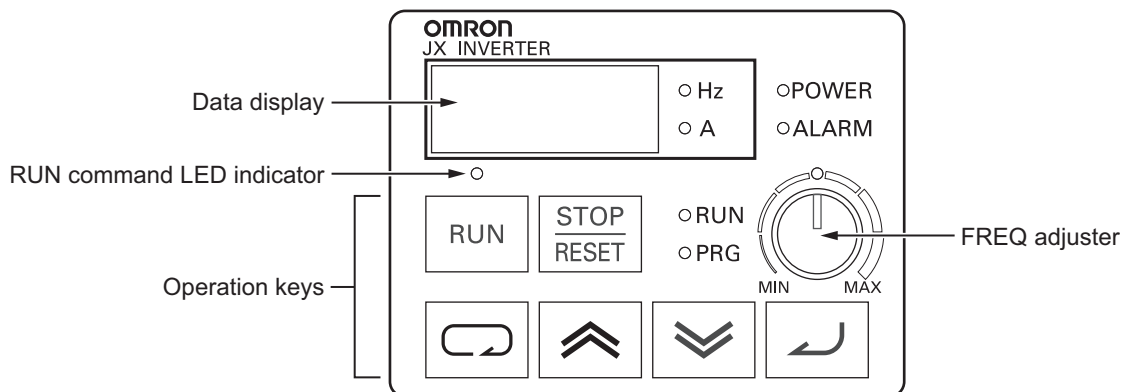

2.7 Digital inputs SINK/SOURCE (NPN/PNP) settings

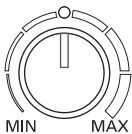

3 PROGRAMMING JX

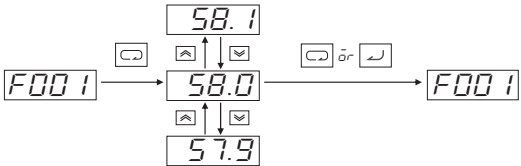
3.1 Digital operator



Item	Name	Description
○POWER	POWER LED indicator	Lit when the power is supplied to the control circuit.
○ALARM	ALARM LED indicator	Lit when an inverter error occurs.
○RUN	RUN (during RUN) LED indicator	Lit when the inverter is running.
○PRG	PROGRAM LED indicator	Lit when the set value of each function is indicated on the data display. Blinks during warning (when the set value is incorrect).
	Data display	Displays relevant data, such as frequency reference, output current and set values.
○ Hz ○ A	Data display LED indicator	Lit according to the indication on the data display. Hz: Frequency A: Current
	Volume LED indicator	Lit when the frequency reference source is set to the FREQ adjuster.
	FREQ adjuster	Sets a frequency. Available only when the frequency reference source is set to the FREQ adjuster. (Check that the Volume LED indicator is lit.)
○	RUN command LED indicator	Lit when the RUN command is set to the Digital operator. (The RUN key on the Digital operator is available for operation.)
	RUN key	Activates the inverter. Available only when operation via the Digital operator is selected. (Check that the RUN command LED indicator is lit.) Forward/Reverse rotation depends on "F004" setting.
	STOP/RESET key	Decelerates and stops the inverter. Functions as a reset key if an inverter error occurs.
	Mode key	Switches between: the monitor mode (d□□□), the basic function mode (F□□□), and the extended function mode (A□□□, b□□□, c□□□, H□□□). With this key, you can always change the display as follows. [Supplemental information] To jump to "d001" from any function mode, hold down the Mode key for 3 seconds. 
	Enter key	Enters and stores changed data. (To change the set value, be sure to press the Enter key.) Do not press the Enter key if you don't want to store any changes, for example, if you have changed the data inadvertently.
	Increment key	Changes the mode. Also, increases the set value of each function.
	Decrement key	Changes the mode. Also, decreases the set value of each function.

3.2 Keypad navigation

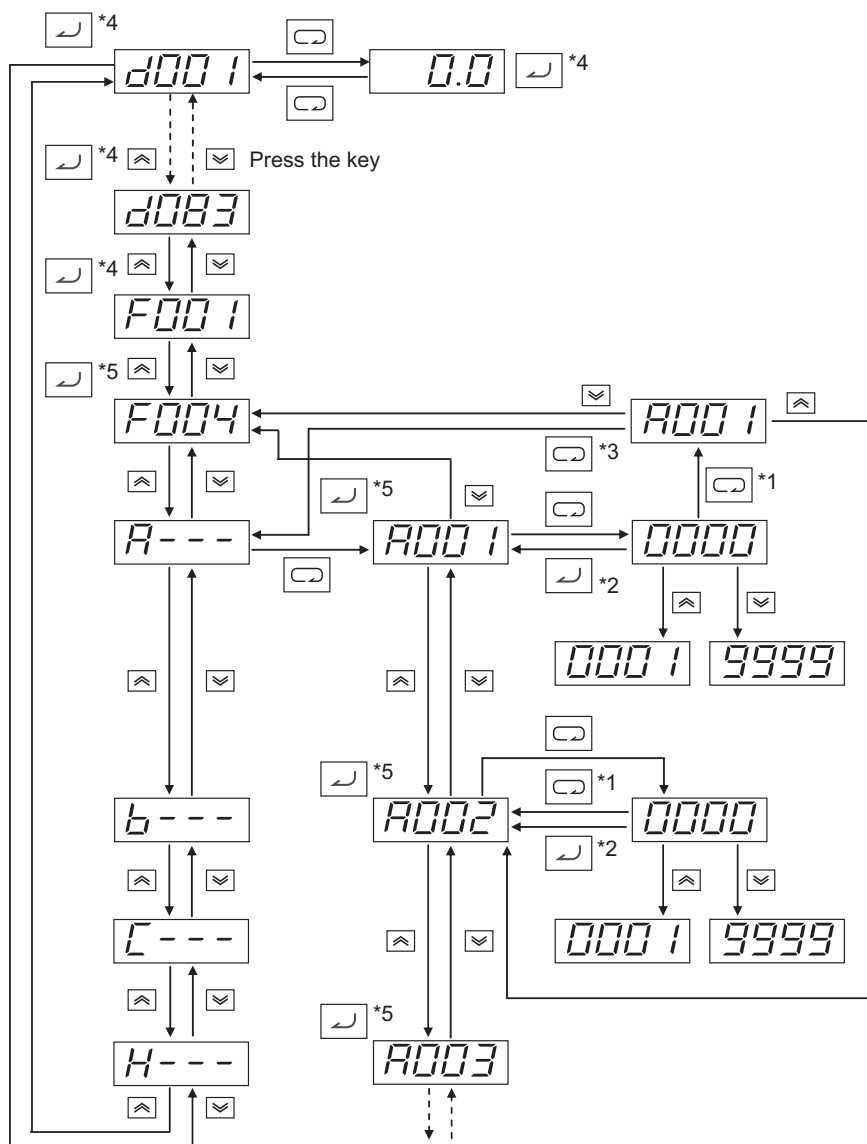

*1. Data is not stored by pressing the Mode key.

*2. Press the Enter key to store the data.

*3. When you press the Mode key after you return to the parameter number display without storing data in the extended function mode, the mode selection function is selected.

*4. When you press the Enter key with d□□□ or F001 displayed, the monitor value is stored as the initial display that appears when the power is turned on.

*5. When you press the Enter key, the first digit of each parameter setting is stored as the initial display that appears when the power is turned on.

(Example: F002, A---, etc.)

* To display a specific monitor when the power is turned on, press the Enter key with that monitor displayed. If a parameter for an extended function code is stored after pressing the Enter key, however, that code (A□□□, b□□□, C□□□, d□□□ or H□□□) appears at the next power-on. To prevent this, always press the Enter key again with the desired monitor displayed after storing a parameter.

3.3 Parameter initialization

- Initialize the parameters using the following procedure.
- To initialize the parameters, set parameter b084 to “02”.

Key sequence	Display example	Description
		Power On
		Press the Mode key once, and then press the Decrement key three times to display “b---”.
		Press the Mode key. “b001” is displayed.
		Use the Increment or Decrement key to display “b084”.
		Press the Mode key. The set value in “b084” is displayed.
		Use the Increment or Decrement key to display “02”.
		Press the Enter key. The set value is entered and “b084” is displayed.
		Press the STOP/RESET key while holding down the Mode and Decrement keys simultaneously. When the display blinks, release the STOP/RESET key first, and then the Mode and Decrement keys.
		Displays initialization.
(In 1 s)		The parameter number is displayed again in approximately 1 s.

3.4 Basic settings

After selecting the inverter mode follow next steps for a basic operation of the inverter

- Select frequency reference source on parameter A001

Parameter	Parameter name	Details
A001	Frequency reference selection	00: Digital operator (FREQ adjuster) 01: Terminal
A201	2nd frequency reference selection	02: Digital operator (F001) 03: ModBus communication 10: Frequency operation result

- Select Run command source on parameter A002

Parameter	Parameter name	Details
A002	RUN command selection	01: Terminal
A202	2nd RUN command selection	02: Digital operator 03: ModBus communication

- Adjust the stopping method by b091 and the acceleration/deceleration ramps on parameters F002 and F003

Parameter	Parameter name	Details
b091	Stop selection	00: Deceleration to stop 01: Free-run stop
F002	Acceleration time 1	0.01 to 3000. s
F202	2nd acceleration time 1	
F003	Deceleration time 1	0.01 to 3000. s
F203	2nd deceleration time 1	

- Set the motor base frequency and AVR voltage of the motors in parameters A003 and A082

Parameter	Parameter name	Details
A003	Base frequency	30. to Max. frequency [A004]
A203	2nd base frequency	30. to Max. frequency [A204]
A082	AVR voltage selection	200-V class: 200/215/220/230/240 V 400-V class: 380/400/415/440/460/480 V

- Set the motor data: rated current (b012), rated power (H003) and number of poles (H004)

Parameter	Parameter name	Details
b012	Electronic thermal level	0.2 x Rated current to 1.0 x Rated current
b212	2nd electronic thermal level	
H003	Motor capacity selection	200-V class: 0.2/0.4/0.75/1.5/2.2/3.7/5.5/7.5 kW
H203	2nd motor capacity selection	400-V class: 0.4/0.75/1.5/2.2/3.7/5.5/7.5 kW
H004	Motor pole number selection	2/4/6/8 poles
H204	2nd motor pole number selection	

At this point the inverter is ready to run the motor for the first time, but first review this check-list:

- Verify the power LED is ON. If not, check the power connections.
- Make sure the motor is disconnected from any mechanical load.
- Make sure that you have a frequency reference checking the content of F001.
- Now give the RUN command from the selected source. The RUN LED will turn ON.
- The motor should start turning.
- Remove the RUN command or press the STOP key to stop the motor rotation.

3.5 Ramps adjustment

The basic frequency (speed) profile is defined by parameters contained in the “F” Group as shown to the right. The set running frequency is in Hz, but acceleration and deceleration are specified in the time duration of the ramp (from zero to maximum frequency, or from maximum frequency to zero).

Acceleration 1 and Deceleration 1 are the standard default accel and decel values for the main profile. Accel and decel values for an alternative profile are specified by using parameters A092 through A093.

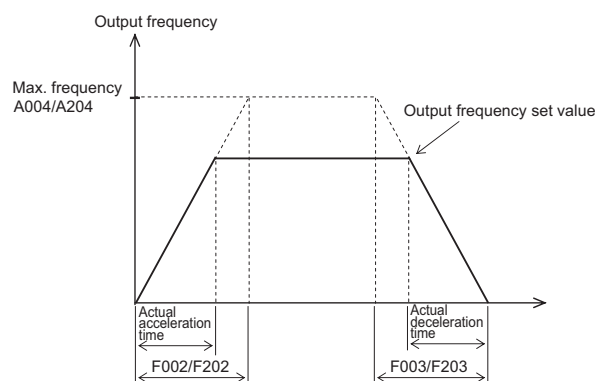

Parameter	Parameter name	Description
A004	Maximum frequency	30. to 400. Hz
A204	2nd maximum frequency	
b082	Starting frequency	0.5 to 9.9 Hz
F001	Output frequency setting/monitor	Starting frequency to 1st or 2nd max. frequency
F002	Acceleration time 1	0.01 to 3000. s
F202	2nd acceleration time 1	

F003	Deceleration time 1	0.01 to 3000. s
F203	2nd deceleration time 1	

Standard acceleration and deceleration is linear. The inverter CPU can also calculate an S-curve acceleration or deceleration curve as shown. Even if the shape of the ramps change the time keeps being the same one set in F002/F003.

Curve settings for acceleration and deceleration are independently selected. To enable the S-curve, use function **A097** (acceleration) and **A098** (deceleration).

Parameter	Parameter name	Description
A097	Acceleration pattern selection	00: Line
A098	Deceleration pattern selection	01: S-shape curve

This table shows the different acceleration shapes:

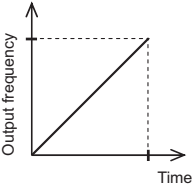
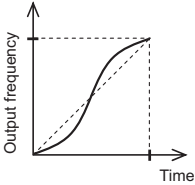
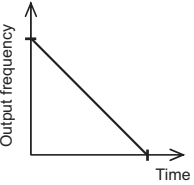
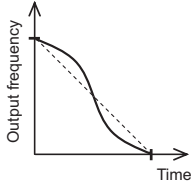
Parameter no.	Set value	
	00	01
	Line	S-shape curve
A097 (Acceleration)		
A098 (Deceleration)		
Description	Accelerates/decelerates linearly before reaching the set output frequency value.	Helps prevent the collapse of cargo on the elevating machine or conveyor.

3.6 DC injection braking

The DC injection braking feature can provide additional stopping torque during deceleration or before acceleration and is particularly useful at low speeds when normal deceleration torque is minimal. This function injects a DC voltage into the motor windings which generates a DC current that force the motor to stop.

There are several modes available depending on the application requirements:

- Normal DC injection braking is used when A051 is set to "01" (Enable during stop) and the RUN command (FW/RV) is turned OFF, at the moment that deceleration stops the DC injection brake starts with a settable power (A054) and duration (A055). Additionally is possible to specify a wait time between the end of the ramp and the DC injection braking on parame-

ter A053, during which the motor will free run. If free-run is selected as stopping method the DC injection braking will start just when the Run commands turns OFF.

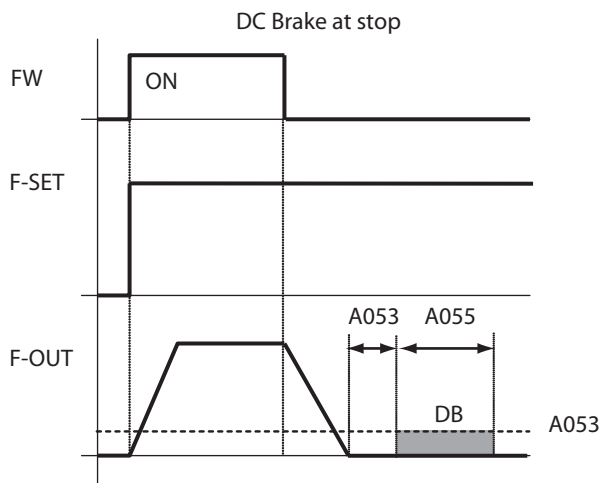

- DC injection braking by frequency detection can be selected setting A051 to “02” (Frequency control). In this case DC injection braking operates when the output frequency comes down to the one you specified in A052 while the RUN command is still active. External DB and internal DC injection braking are invalid during the frequency detection mode.

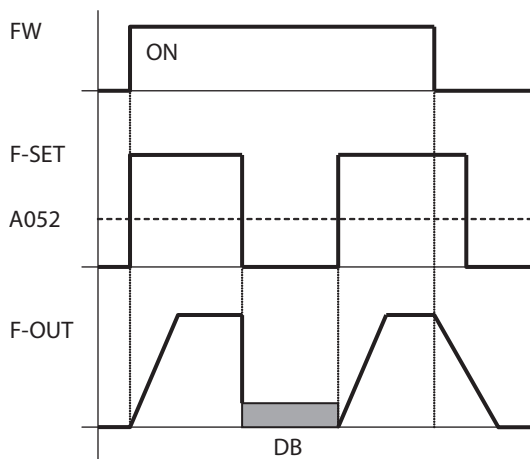

Example 1: Step change in F-SET

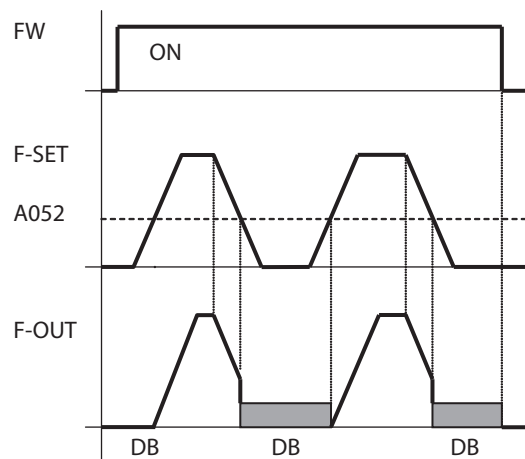

Example 2: Analog change in F-SET

- Last option is to trigger the DC injection by a digital input when the terminal (DB) is turned ON. Set parameters A053 and A054 to setup this function. There are several cases depending on the motor rotation and Run command status.

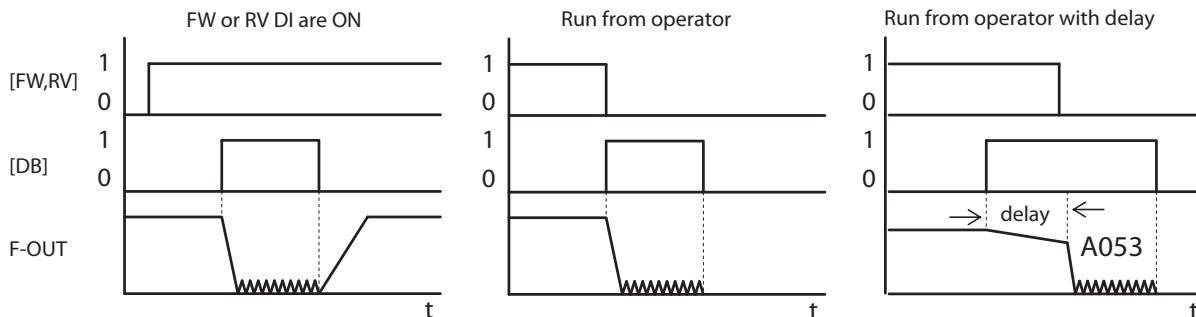

Parameter	Parameter name	Description
A051	DC injection braking selection	00: Disabled 01: Enabled 02: Frequency control [A052 set value]
A052	DC injection braking frequency	0.0 to 60.0 Hz

Parameter	Parameter name	Description
A053	DC injection braking delay time	The delay from the end of controlled deceleration to start of DC braking (motor free runs until DC braking begins) 0.0 to 5.0 s
A054	DC injection braking power	0. to 100.%
A055	DC injection braking time	Sets the duration for DC braking 0.0 to 60.0 s
A056	DC injection braking method selection	00: Edge operation 01: Level operation

Be careful to avoid specifying too long braking time or too high carrier frequency that can cause motor overheating. If you use DC injection braking is recommended to use motors with a built-in thermistor and wire it to inverter's thermistor input.

3.7 V/F curve

The inverter generates the motor output according to the V/F algorithm selected on parameter A044. The factory default is Constant torque ("00"). Review following descriptions to help you choose the best torque control algorithm for your application:

Parameter	Parameter name	Description
A044	V/F characteristics selection	00: Constant torque characteristics (VC) 01: Reduced torque characteristics (VP 1.7th power)
A244	2nd V/F characteristics selection	06: Special reduced torque characteristics (Special VP)

- **Constant torque characteristics (VC)** - Output voltage is proportional to output frequency. While proportional from 0 Hz to base frequency, the output voltage is constant from base to maximum frequencies regardless of the frequency.

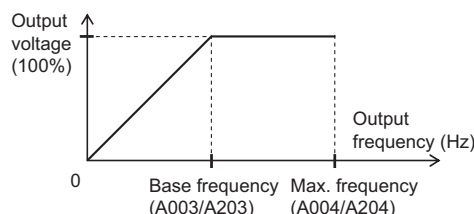

- **Reduced torque characteristics (VP 1.7th power)** - Suitable for a fan or pump that does not require large torque in a low speed range. These provide high efficiency, reduced noise and vibration, owing to reduced output voltage in a low speed range.

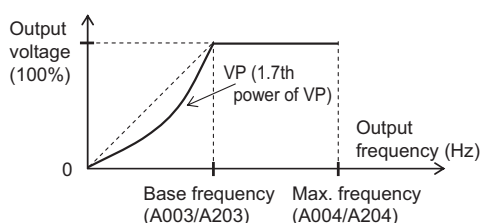

- **Special reduced torque characteristics (Special VP)** - Suitable for a fan or pump that requires torque in a low speed range using VC characteristics at this area.

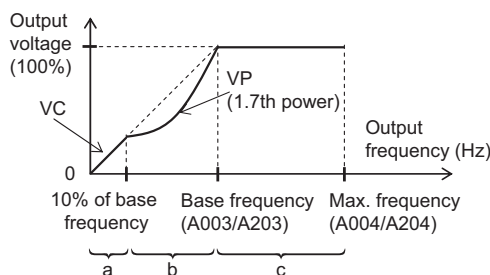

Period a: Provides constant torque characteristics (VC) within a range from 0 Hz to 10% of base frequency. (Example) If the base frequency is 50 Hz, the inverter provides constant torque characteristics within a range from 0 to 5 Hz.

Period b: Provides reduced torque characteristics within a range from 10% to 100% of the base frequency. The inverter outputs voltage based on a curve of the 1.7th power of the frequency.

Period c: Provides constant voltage within a range from the base frequency to the maximum frequency.

3.8 Torque boost function

This function helps to compensate insufficient motor torque in a low speed range.

- Compensates the voltage drop caused by the primary resistance of the motor or wiring increasing the torque in a low speed range.
- To select the simple torque boost in the torque boost selection (A041/A241), set the motor capacity selection (H003/H203) and motor pole number selection (H004/H204) according to your motor.

Manual torque boost (A042/A242, A043/A243)

- Adds the voltage set in A042/A242 and A043/A243 to the V/f characteristics, and outputs the resulting voltage. The addition value is set in percentage terms based on the AVR voltage selection (A082) as 100%.
- The manual torque boost frequency (A043/A243) is set in percentage terms based on the base frequency as 100%.
- If you raise the set value of the manual torque boost (A042/A242) be careful about motor overexcitation. Otherwise the motor may burn out.

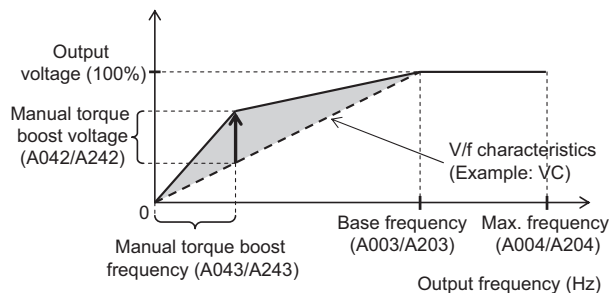

Simple torque boost (A041/A241)

- If simple torque boost is selected in the torque boost selection (A041/A241: 01), it operates to adjust the output voltage depending on the load level.
- To select simple torque boost in the torque boost selection (A041/A241), set the motor capacity selection (H003/H203) and motor pole number selection (H004/H204) according to your motor.
- You may avoid a possible overcurrent trip during deceleration by always setting the AVR selection to ON (A081: 00).
- Sufficient characteristics may not be obtained if you select two or more lower rank motor size than specified.

Parameter	Parameter name	Description
A041	Torque boost selection	00: Manual torque boost only
A241	2nd torque boost selection	01: Automatic (simple) torque boost
A042	Manual torque boost voltage	Can boost starting torque between 0 and 20% above normal V/f curve 0.0 to 20.0%
A242	2nd manual torque boost voltage	
A043	Manual torque boost frequency	Sets the frequency of the V/f breakpoint for torque boost 0.0 to 50.0%
A243	2nd manual torque boost frequency	

3.9 Digital inputs

The function codes in the following table let you assign between a wide range of functions to any of the five logic inputs for the 3G3JX inverter. The functions C001 through C005 configure the terminals [1] through [5] respectively. The “value” of these particular parameters is not a scalar value, but it is a discrete number that selects one option from many available options.

Input function summary table				
Option code	Terminal symbol	Function name	Description	
00	FW	Forward command	ON	Inverter is in Run Mode, motor runs forward
			OFF	Inverter is in Stop Mode, motor stops
01	RV	Reverse command	ON	Inverter is in Run Mode, motor runs reverse
			OFF	Inverter is in Stop Mode, motor stops
02	CF1	Multi-step speed setting binary 1	ON	Binary encoded speed selection bit 3 to bit 0
03	CF2	Multi-step speed setting binary 2		
04	CF3	Multi-step speed setting binary 3		
05	CF4	Multi-step speed setting binary 4		
06	JG	Jogging	ON	Inverter is in Run Mode, output to motor runs at jog parameter frequency
07	DB	External DC injection braking	ON	DC injection braking will be applied during deceleration
08	SET	2nd control selection	ON	The inverter uses 2nd motor parameters for generating frequency output to motor
			OFF	The inverter uses 1st (main) motor parameters for generating frequency output to motor
09	2CH	2-step acceleration/deceleration	ON	Frequency output uses 2nd-stage acceleration and deceleration values
			OFF	Frequency output uses standard acceleration and deceleration values
11	FRS	Free-run stop	ON	Causes output to turn OFF, allowing motor to free run (coast) to stop
12	EXT	External trip	ON	When assigned input transitions OFF to ON, inverter latches trip event and displays E 12
			OFF	No trip event for ON to OFF, any recorded trip events remain in history until reset
13	USP	Power recovery restart protection	ON	The inverter will not resume a Run command
			OFF	The inverter will resume a Run command that was active before power loss
15	SFT	Soft lock	ON	The keypad and remote programming devices are prevented from changing parameters
			OFF	The parameters may be edited and stored
16	AT	Analog input switching	ON	Refer to Analog Input selection
			OFF	

Input function summary table

Option code	Terminal symbol	Function name	Description	
18	RS	Reset	ON	The trip condition is reset, the motor output is turned OFF, and powerup reset is asserted
			OFF	Normal power-ON operation
19	PTC	Thermistor input	ON	The inverter can detect motor temperature and, if the temperature exceeds the specified level, trips to shut off the output (E35). The level is fixed.
			OFF	If the thermistor is not connected, the inverter trips (E35) to shut off the output
20	STA	3-wire start	ON	Starts the motor rotation
21	STP	3-wire stop	ON	Stops the motor rotation
22	F/R	3-wire forward/reverse	ON	Selects the direction of motor rotation: ON = FWD. While the motor is rotating, a change of F/R will start a deceleration, followed by a change in direction
			OFF	Selects the direction of motor rotation: OFF = REV. While the motor is rotating, a change of F/R will start a deceleration, followed by a change in direction
23	PID	PID enabled/disabled	ON	Temporarily disables PID loop control. Inverter output turns OFF as long as PID Enable is active (A071=01)
			OFF	Has no effect on PID loop operation, operates normally if PID Enable is active (A071=01)
24	PIDC	PID integral reset	ON	Resets the PID loop controller. Main consequence is that integrator sum is forced to zero
27	UP	UP/DWN function accelerated	ON	Accelerates (increases output frequency) motor from current frequency
28	DWN	UP/DWN function decelerated	ON	Decelerates (decreases output frequency) motor from current frequency
29	UDC	UP/DWN function data clear	ON	Clears the UP/DWN frequency memory by forcing it to equal the set frequency parameter F001.
31	OPE	Forced operator	ON	Forces the source of the output frequency setting A001 and the source of the Run command A002 to be from the digital operator
			OFF	Source of output frequency set by A001 and source of Run command set by A002 is used
50	ADD	Frequency addition	ON	Adds the A145 (add frequency) value to the output frequency
			OFF	Does not add the A145 value to the output frequency
51	F-TM	Forced terminal block	ON	Force inverter to use input terminals for output frequency and Run command sources
			OFF	Source of output frequency set by A001 and source of Run command set by A002 is used
52	RDY	Ready function	ON	The inverter is ready
			OFF	Normal stop status
53	SP-SET	Special 2nd function selection	ON	Enables the parameter for the special 2nd motor
			OFF	Disables the parameter for the special 2nd motor
64	EMR	Emergency shutoff	ON	Emergency shutoff is ON
255	no	No function	-	Digital input not used

All this functions could be assigned to any of the multi-function inputs on parameters C001 to C005, select if the input will be normally open or normally close and the response time of the input.

Parameter	Parameter name	Description
C001	Multi-function input 1 selection	Refer to upper table for available settings
C201	2nd multi-function input 1 selection	
C002	Multi-function input 2 selection	
C202	2nd multi-function input 2 selection	
C003	Multi-function input 3 selection	
C203	2nd multi-function input 3 selection	
C004	Multi-function input 4 selection	
C204	2nd multi-function input 4 selection	
C005	Multi-function input 5 selection	
C205	2nd multi-function input 5 selection	
C011	Multi-function input 1 operation selection	00: NO (normally open) 01: NC (normally closed)
C012	Multi-function input 2 operation selection	
C013	Multi-function input 3 operation selection	
C014	Multi-function input 4 operation selection	
C015	Multi-function input 5 operation selection	

An input terminal configured for option code 18 ([RS] Reset command) cannot be configured for normally closed operation.

3.10 Digital outputs

Function codes in the following table let you assign different options into logical outputs (terminal [11] and [AL]) on parameters C021 and C026.

Input function summary table				
Option code	Terminal symbol	Function name	Description	
00	RUN	Signal during RUN	ON	When the inverter is in Run Mode
01	FA1	Constant speed arrival signal	ON	When output to motor is at the set frequency
			OFF	When output to motor is OFF, or in any acceleration or deceleration ramp
02	FA2	Over set frequency arrival signal	ON	When output to motor is at or above the set frequency, even if in acceleration (C042) or deceleration (C043) ramps
			OFF	When output to motor is OFF, or at a level below the set frequency
03	OL	Overload warning	ON	When output current is more than the set threshold (C041) for the overload signal
04	OD	Excessive PID deviation	ON	When PID error is more than the set threshold for the deviation signal
05	AL	Alarm output	ON	When an alarm signal has occurred and has not been cleared
06	Dc	Disconnection detection	ON	When the inverter is in trip status
07	FBV	PID FB status output	ON	Shifts output when exceeding the upper limit or falling below the lower limit
08	NDc	Network error	ON	The communication watchdog timer times out
09	LOG	Logic operation output	ON	This function outputs a logic operation result of combination of two functions
10	ODc	Not used	-	-
43	LOC	Light load detection signal	ON	Motor current is less than the specified value (C039)

In the same way of that the digital inputs is possible to choose between normally close and normally open and even is possible to use some On and Off delay for each of the outputs.

Parameter	Parameter name	Description
C021	Multi-function output terminal 11 selection	Refer to upper table for available settings
C026	Relay output (AL2, AL1) function selection	
C031	Multi-function output terminal 11 contact selection	00: NO contact at AL2; NC contact at AL1 01: NC contact at AL2; NO contact at AL1
C036	Relay output (AL2, AL1) contact selection	

3.11 Analog inputs

Two types of external analog inputs are available for frequency reference plus the built-in VR. For voltage input, you can set a frequency from 0 to maximum by applying a voltage from 0 to 10 V between inputs O and L. For current input, apply 4 to 20 mA between inputs OI and L. Note that voltage and current cannot be input simultaneously. Also, do not connect the signal lines for inputs O and OI simultaneously.

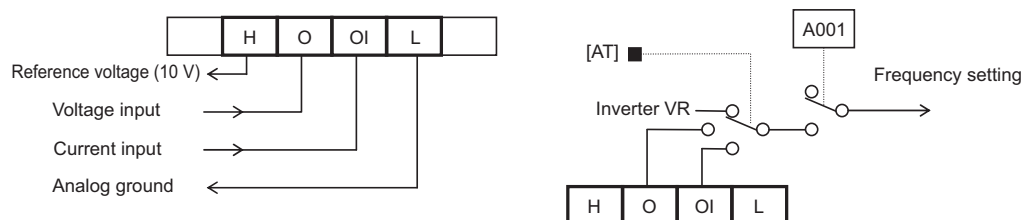

Switching between the inputs could be done by a digital input setting parameter A005.

Parameter	Parameter name	Data	Default setting	Unit
A005	O/OI selection	00: Switches between O/OI via terminal AT 02: Switches between O/FREQ adjuster via terminal AT 03: Switches between OI/FREQ adjuster via terminal AT 04: O input only 05: OI input only	02	-
Related parameters		A011 to A016, A101 to A105, A151 to A155, C001 to C005, C081, C082		
Required settings		A001= 01		

Allocate AT (16) to any of the multi-function inputs with the frequency reference set to the terminal block (A001 or A201 = 01).

Data	Symbol	Function name	Status	Description
16	AT	Analog input switching	ON	Depends on the combination with the A005 setting (see the below table)
			OFF	Same as above
Related parameters		C001 to C005		

The settings are as follows. (VR: FREQ adjuster). If AT is not allocated to any of the multi-function input, this means the AT input = OFF in the above table.

A005 set value	00		02		03		04		05	
AT terminal input status	OFF	ON	OFF	ON	OFF	ON	OFF	ON	OFF	ON
Analog input enabled	O-L	OI-L	O-L	VR	OI-L	VR	O-L		OI-L	

3.12 Analog output AM terminal

This function allows you to monitor the output frequency and current from the AM terminal on the control terminal block. Analog voltage output from 0 to 10 V.

AM selection

Select a signal to output from the following table:

Parameter	Parameter name	Description
C028	AM selection	00: Output frequency 01: Output current

- Output frequency** - Outputs the voltage according to the output frequency, with the maximum frequency being full scale. This is intended for display indication and cannot be used as a line speed signal. Through the accuracy is $\pm 5\%$, this could be exceeded depending on your meter. Outputs a frequency obtained by multiplying the output frequency by the conversion coefficient [b086], with the maximum frequency being full scale.

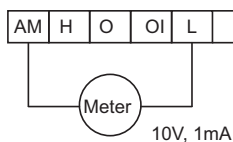

- Output current** - Outputs a current value with 200% of the inverter rated voltage being full scale. The output method is the same as the output frequency. Monitor accuracy is $\pm 10\%$ at the halfway point of base frequency.

AM adjustment

You can adjust the calibration of the analog voltage (0 to 10 VDC) from the AM terminal on the control terminal block by using the inverter setting.

Parameter	Parameter name	Data	Default setting	Unit
b080	AM adjustment	0. to 255. (adjust to the scale)	100.	-
C086	AM offset adjustment	0.0 to 10.0 (see the figure below)	0.0	V
Related parameters		A011 to A015, A101 to A105		

Note: If the offset (C086) is changed, the point to reach 10 V changes accordingly because of parallel movement. To avoid this, adjust the offset (C086) before the gain (b080).

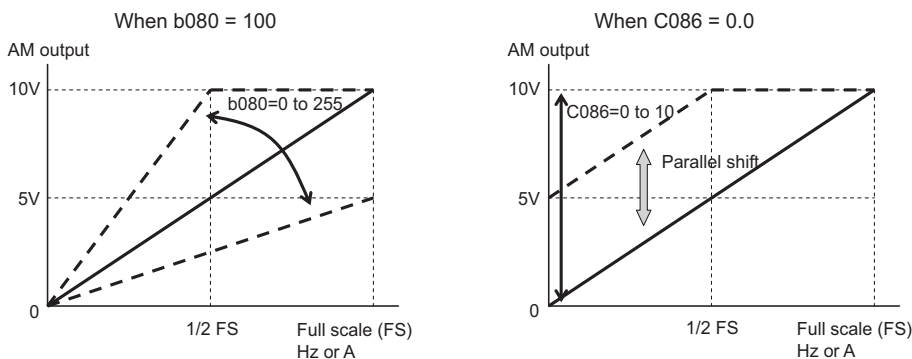

3.13 Electronic thermal function

This function electronically protects the motor from overheating.

- Causes an overload trip (E05) to protect the motor from overheating by setting according to the motor rated current.
- Provides the most appropriate protection characteristics, taking into account the decline of a standard motor cooling capability at a low speed.
- To set a value over the rated current of the motor, be careful of any temperature rise of the motor.

Parameter	Parameter name	Description
b012	Electronic thermal level	0.2 x Rated current to 1.0 x Rated current
b212*	2nd electronic thermal level	
b013	Electronic thermal characteristics selection	00: Reduced torque characteristics 1
b213*	2nd electronic thermal characteristics selection	01: Constant torque characteristics
		02: Reduced torque characteristics 2
Related parameters		C021

* To switch to the 2nd control, allocate 08 (SET) to the multi-function input terminal and then turn it on.

Electronic thermal level (motor protection level)

(Example) 3G3JX-AB007, rated current: 4.0 A, setting range: 0.8 to 4.0 A.

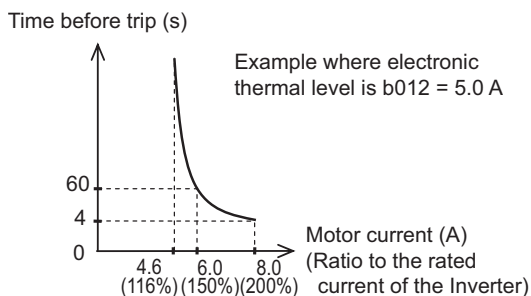

Electronic thermal characteristics

Frequency characteristics are multiplied by the b012/212 set value above. The lower the output frequency is, the lower the cooling capability of the standard motor's self-cooling fan.

- **Reduced torque characteristics 1** - Multiplied by the time limit characteristics set in b012/212 for each frequency.
- **Constant torque characteristics** - Do not skip this setting when using a constant torque motor. Multiplied by the time limit characteristics set in b012/212 for each frequency.
- **Reduced torque characteristics 2** - Multiplied by the limit characteristics set in b012/212 for each frequency.

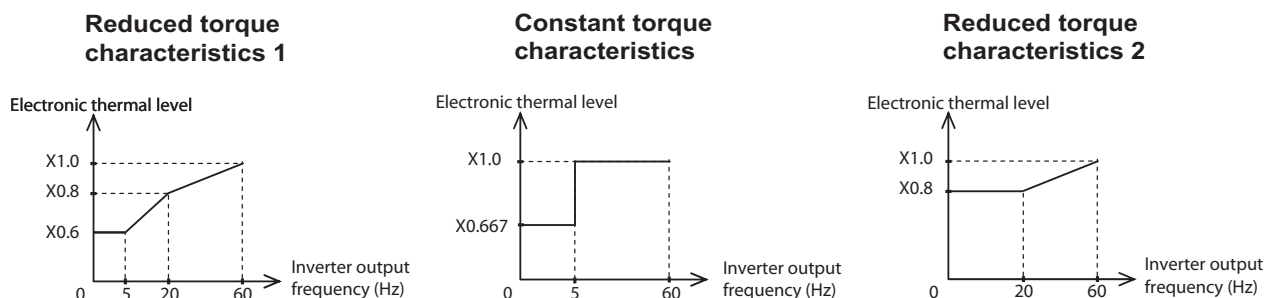

3.14 Carrier frequency

You can change the PWM waveform carrier frequency output from the inverter.

Parameter	Parameter name	Data	Default setting	Unit
b083	Carrier frequency	2.0 to 12.0	3.0	kHz

- With the carrier frequency set high, you can reduce metallic noise from the motor. However, this may increase electrical noise or leakage current from the inverter.
- Carrier frequency adjustment also helps avoid mechanical or motor resonance.
- To raise the carrier frequency, reduce the output current (or derate the rated current). Check user's manual for details.

3.15 PID function

This function enables process control such elements as flow rate, air volume, and pressure.

Parameter	Parameter name	Data	Default setting	Unit
A071	PID selection	00: Disabled 01: Enabled	00	-
A072	PID P gain	0.2 to 5.0	1.0	-
A073	PID I gain	0.0 to 150.0	1.0	s
A074	PID D gain	0.00 to 100.0	0.0	s
A075	PID scale	0.01 to 99.99	1.00	Time
A076	PID feedback selection	00: OI 01: O 02: RS485 communication 10: Operation function output	00	-
A077	Reverse PID function	00: OFF (Deviation = Target value - Feedback value) 01: ON (Deviation = Feedback value - Target value)	00	-
A078	PID output limit function	0.0 to 100.0	0.0	%
C044	PID deviation excessive level	0.0 to 100.0	3.0	%
C052	PID FB upper limit	0.0 to 100.0	100.0	%
C053	PID FB lower limit		0.0	
Related parameters		d004, A001, A005, C001 to C005, C021, C026		

- To use this function, set A071 to 01.
- To switch between enable/disable via the terminal block (external signal), allocate 23 (PID enable/disable) to the desired multi-function input. Select OFF for enable and ON for disable.

Basic structure of PID control (example)

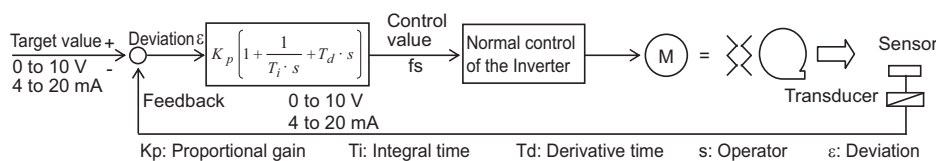

• PID enable/disable

Data	Symbol	Function name	Status	Description
23	PID	PID enabled/disabled	ON	Disables the PID function
			OFF	Does not affect the PID function
Related parameters		C001 to C005		

• Excessive deviation/output

Data	Symbol	Function name	Status	Description
04	OD	Excessive PID deviation	ON	The PID deviation has exceeded the C044 set value
			OFF	The PID deviation has not reached the C044 set value
Available output terminals		11-CM2, AL2-AL0 (or AL1-AL0)		
Requires settings		C021, C026, C044		

• **PID feedback (FB) upper/lower limit**

Data	Symbol	Function name	Status	Description
07	FBV	PID FB status output	ON	Shifts output when exceeding the upper limit or falling below the lower limit
			OFF	
Available output terminals		11-CM2, AL2-AL0 (or AL1-AL0)		
Requires settings		C021, C026, C052, C053		

• **PID integral reset**

Data	Symbol	Function name	Status	Description
24	PIDC	PID integral reset	ON	Forcibly sets the PID integral value to zero
			OFF	Does not affect the PID function
Related parameters		C001 to C005		

3.16 Overload limit/warning

This function helps prevent an overcurrent trip due to rapid load fluctuation in acceleration or constant speed operation.

Parameter	Parameter name	Data	Default setting	Unit
b021	Overload limit selection	00: Disabled	01	-
b221*	2nd overload limit selection	01: Enabled in acceleration/constant speed operation 02: Enabled in constant speed operation		
b022	Overload limit level	0.1 x Rated current to 1.5 x Rated current	1.5 x Rated current	A
b222*	2nd overload limit level			
b023	Overload limit parameter	0.1 to 3000.0	1.0	s
b223*	2nd overload limit parameter			
b028	Overload limit source selection	00: b022, b222 set values	00	-
b228*	2nd overload limit source selection	01: Input terminal O		
C041	Overload warning level	0.0: Does not operate	Rated current	A
C241*	2nd overload warning level	0.1 x Rated current to 2.0 x Rated current		
Related parameters		C021, C026		

* To switch to the 2nd control, allocate 08 (SET) to the multi-function input terminal and then turn it on.

- The inverter monitors the motor current during acceleration or constant speed operation. If it reaches the overload limit level, the output frequency is lowered automatically according to the overload limit parameter.

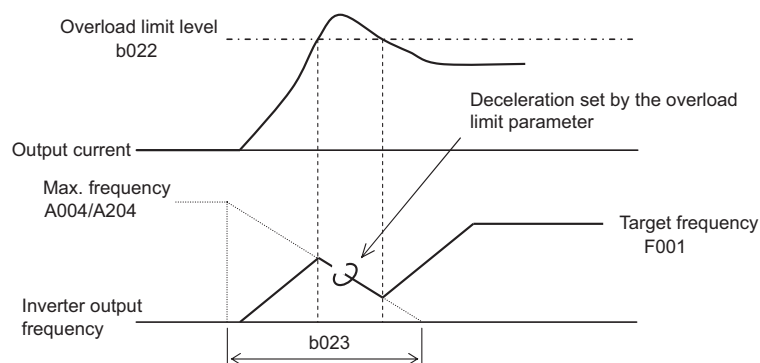

- For more detailed information please check the user's manual.

3.17 Overvoltage control function

This function helps avoid an overvoltage trip during deceleration. Note that the actual deceleration time may be longer than the set value. This function automatically keeps DC voltage at the set level during deceleration. The aim of this function is the same as the overvoltage LAD stop function, described in b130 and b131. However, these functions have different deceleration characteristics and you can select either function according to your system.

Parameter	Parameter name	Data	Default setting	Unit
b055	Overvoltage protection proportional gain during deceleration	0.2 to 5.0	0.2	-
b056	Overvoltage protection integral time during deceleration	0.0 to 150.0	0.2	s

Parameter	Parameter name	Data	Default setting	Unit
b130	Overvoltage LAD stop function	00: Disabled 01: Enabled	00	-
b131	Overvoltage LAD stop function level setting	200-V class: 330. to 395. 400-V class: 660. to 790.	380/760	V
b133	Overvoltage protection function selection during deceleration	00: Disabled 01: Enabled	00	-
b134	Overvoltage protection level setting during deceleration	200-V class: 330. to 395. 400-V class: 660. to 790.	380/760	V

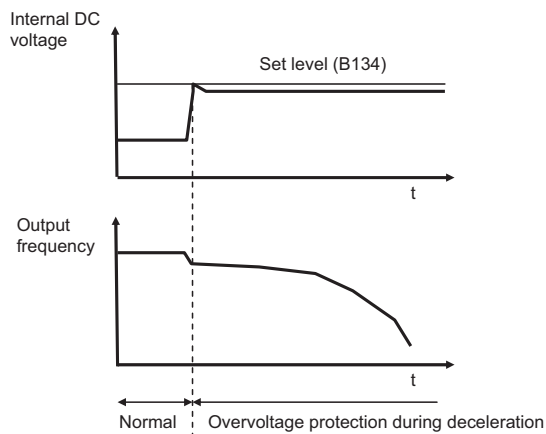

3.18 Controlled stop at power loss

This function decelerates the inverter by a controlled stop to avoid a trip or free running in case of power supply disconnection or momentary power interruption during operation.

Parameter	Parameter name	Data	Default setting	Unit
b050	Selection of non-stop function at momentary power interruption	00: Disabled 01: Enabled (stop) 02: Enabled (restart)	00	-
b051	Starting voltage of non-stop function at momentary power interruption	0.0 to 1000.	0.0	V
b052	Stop deceleration level of non-stop function at momentary power interruption	0.0 to 1000.	0.0	V
b053	Deceleration time of non-stop function at momentary power interruption	0.01 to 3000.	1.0	s
b054	Deceleration starting width of non-stop function at momentary power interruption	0.0 to 10.0	0.0	Hz

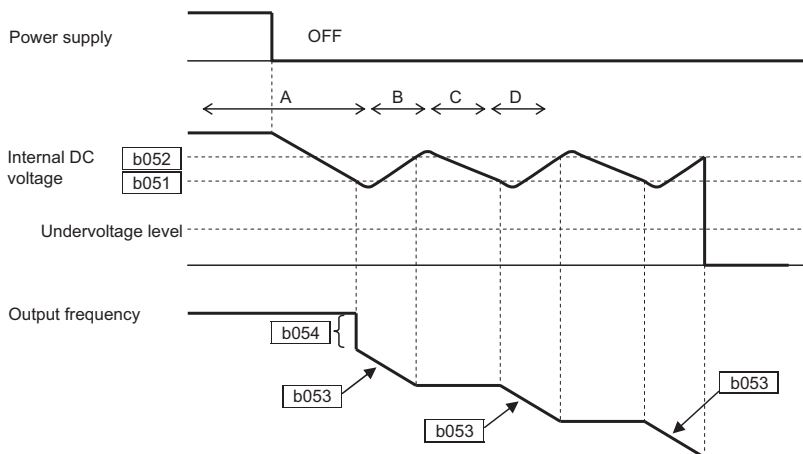

PARAMETER LIST

4 PARAMETER LIST

The PDU (Process Data Unit) register number are addressed starting at zero. Therefore register numbered “0012h” addressed as “0011h”. Register address value (transmitted on Modbus line) is 1 less than the Register number of the table

4.1 Parameter group D: Monitors

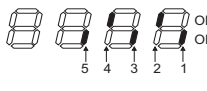
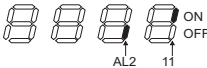
Parameter No.	Function name	Monitoring or data range (digital operator)	Default setting	Changes during operation	Unit	Modbus address (hex)
d001	Output frequency monitor	0.0 to 400.0	-	-	Hz	1002
d002	Output current monitor	0.0 to 999.0	-	-	A	1003
d003	Rotation direction monitor	F: Forward o: Stop r: Reverse	-	-	-	1004
d004	PID feedback value monitor	0.00 to 9999. (Enabled when the PID function is enabled)	-	-	-	1005 (high) 1006 (low)
d005	Multi-function input monitor	 Terminal 4, 2: ON Terminal 5, 3, 1: OFF	-	-	-	1007
d006	Multi-function output monitor	 Terminal 11: ON Terminal AL2: OFF	-	-	-	1008
d007	Output frequency monitor (after conversion)	0.00 to 39960 (Output frequency x Conversion factor of b086)	-	-	-	1009 (high) 100A (low)
d013	Output voltage monitor	0. to 600.	-	-	V	100C
d016	Total RUN time	0. to 99990 hours	-	-	h	100E (high) 100F (low)
d017	Power ON time monitor	0. to 99990 hours	-	-	h	1010 (high) 1011 (low)
d018	Fin temperature monitor	0.0 to 200.0	-	-	°C	116A
d080	Fault frequency monitor	0. to 9999.	-	-	-	0011
d081	Fault monitor 1 (Latest)	Error code (condition of occurrence)	-	-	-	0012 to 001B
d082	Fault monitor 2	Output frequency [Hz] Output current [A] Internal DC voltage [V]	-	-	-	001C to 0025
d083	Fault monitor 3	RUN time [h] ON time [h]	-	-	-	0026 to 002F
d102	DC voltage monitor	0.0 to 999.9	-	-	V	116C
d104	Electronic thermal monitor	0.0 to 100.0	-	-	%	116D

4.2 Parameter group A

Parameter No.	Function name	Monitoring or data range (digital operator)	Default setting	Changes during operation	Unit	Modbus address (hex)
A001	Frequency reference selection	00: Digital operator (FREQ adjuster) 01: Terminal	00	No	-	1019
A201	2nd frequency reference selection	02: Digital operator (F001) 03: Modbus communication 10: Frequency operation result	-	-	-	-
A002	RUN command selection	01: Terminal	02	No	-	101A
A202	2nd RUN command selection	02: Digital operator (F001) 03: Modbus communication	-	-	-	-
A003	Base frequency	30 to maximum frequency [A004]	50	No	Hz	101B
A203	2nd base frequency	30 to 2nd maximum frequency [A204]	-	-	-	150C
A004	Maximum frequency	30. to 400.	50	No	Hz	101C
A204	2nd maximum frequency	-	-	-	-	150D
A005	O/OI selection	00: Switches between O/OI via terminal AT 02: Switches between O/FREQ adjuster via terminal AT 03: Switches between FI/FREQ adjuster via terminal AT 04: O input only 05: OI input only	02	No	-	101D
A011	O start frequency	0.0 to Max. frequency	0.0	No	Hz	1020
A012	O end frequency	-	-	-	-	1022
A013	O start ratio	0. to 100.	0.	No	%	1023
A014	O end ratio	-	100.	-	-	1024
A015	O start selection	00: External start frequency (A011 set value) 01: 0 Hz	01	No	-	1025
A016	O, OI sampling	1. to 17.	8.	No	-	1026
A020	Multi-step speed reference 0	0.0/starting frequency to max. frequency	6.0	Yes	Hz	1029
A220	2nd multi-step speed reference 0	0.0/starting frequency to 2nd max. frequency	-	-	-	150F

PARAMETER LIST

Parameter No.	Function name	Monitoring or data range (digital operator)	Default setting	Changes during operation	Unit	Modbus address (hex)
A021	Multi-step speed reference 1	0.0/starting frequency to max frequency	0.0	Yes	Hz	102B
A022	Multi-step speed reference 2					102D
A023	Multi-step speed reference 3					102F
A024	Multi-step speed reference 4					1031
A025	Multi-step speed reference 5					1033
A026	Multi-step speed reference 6					1035
A027	Multi-step speed reference 7					1037
A028	Multi-step speed reference 8					1039
A029	Multi-step speed reference 9					103B
A030	Multi-step speed reference 10					103D
A031	Multi-step speed reference 11					103F
A032	Multi-step speed reference 12					1041
A033	Multi-step speed reference 13					1043
A034	Multi-step speed reference 14					1045
A035	Multi-step speed reference 15					1047
A038	Jogging frequency	0.00/starting frequency to 9.99	6.00	Yes	Hz	1048
A039	Jogging stop selection	00: Free-run stop 01: Deceleration stop 02: DC injection braking stop	00	No	-	1049
A041	Torque boost selection	00: Manual torque boost only 01: Automatic (simple) torque boost	00	No	-	104A
A241	2nd torque boost selection					1510
A042	Manual torque boost voltage	0.0 to 20.0	5.0	Yes	%	104B
A242	2nd manual torque boost voltage		0.0			1511
A043	Manual torque boost frequency	0.0 to 50.0	2.5	Yes	%	104C
A243	2nd manual torque boost frequency		0.0			1512
A044	V/F characteristics selection	00: Constant torque characteristics (VC) 01: Reduced torque characteristics (VP 1.7th power) 06: Special reduced torque characteristics (Special VP)	00	No	-	104D
A244	2nd V/F characteristics selection					1513
A045	Output voltage gain	20. to 100.	100.	Yes	%	104E
A245	2nd output voltage gain					1514
A051	DC injection braking selection	00: Disabled 01: Enabled 02: Frequency control [A052 set value]	00	No	-	1051
A052	DC injection braking frequency	0.0 to 60.0	0.5	No	Hz	1052
A053	DC injection braking delay time	0.0 to 5.0	0.0	No	s	1053
A054	DC injection braking power	0. to 100.	50	No	%	1054
A055	DC injection braking time	0.0 to 60.0	0.5	No	s	1055
A056	DC injection braking method selection	00: Edge operation 01: Level operation	01	No	-	1056
A061	Frequency upper limit	0.0/frequency lower limit to max frequency	0.0	No	Hz	105A
A261	2nd frequency upper limit	0.0/2nd frequency lower limit to 2nd max frequency				1517
A062	Frequency lower limit	0.0/starting frequency to frequency upper limit	0.0	No	Hz	105B
A262	2nd frequency lower limit	0.0/starting frequency to 2nd frequency upper limit				1518
A063	Jump frequency 1	Jump frequency: 0.0 to 400.0	0.0	No	Hz	105D
A064	Jump frequency width 1	Jump frequency width: 0.0 to 1.0	0.5			105E
A065	Jump frequency 2		0.0			1060
A066	Jump frequency width 2		0.5			1061
A067	Jump frequency 3		0.0			1063
A068	Jump frequency width 3		0.5			1064
A071	PID selection	00: Disabled 01: Enabled	00	No	-	1068
A072	PID P gain	0.2 to 5.0	1.0	Yes	-	1069
A073	PID I gain	0.0 to 150.0	1.0	Yes	s	106A
A074	PID D gain	0.0 to 100.0	0.0	Yes	s	106B
A075	PID scale	0.01 to 99.99	1.00	No	Time	106C
A076	PID feedback selection	00: OI 01: O 02: RS485 communication 10: Operation function result	00	No	-	106D
A077	Reverse PID function	00: OFF (Deviation = Target value - Feedback value) 01: ON (Deviation = Feedback value - Target value)	00	No	-	106E
A078	PID output limit function	0.0 to 100.0	0.0	No	%	106F
A081	AVR selection	00: Always ON 01: Always OFF 02: OFF during deceleration	02	No	-	1070
A082	AVR voltage selection	200-V class: 200/215/220/230/240 400-V class: 380/400/415/440/460/480	200/400	No	V	1071
A085	RUN mode selection	00: Normal operation 01: Energy-saving operation	00	No	-	1072
A086	Energy-saving response/accuracy adjustment	0 to 100	50	No	%	1073
A092	Acceleration time 2	0.01 to 3000.	15.00	Yes	s	1074 (high)
						1075 (low)
A292	2nd acceleration time 2					1519 (high)
		151A (low)				

PARAMETER LIST

Parameter No.	Function name	Monitoring or data range (digital operator)	Default setting	Changes during operation	Unit	Modbus address (hex)
A093	Deceleration time 2	0.01 to 3000.	15.00	Yes	s	1076 (high)
A293	2nd deceleration time 2					1077 (low)
A094	2-step accel/decel selection	00: Switched via multi-function input 09 (2CH)	00	No	-	1078
A294	2nd 2-step accel/decel selection	01: Switched by setting				151D
A095	2-step acceleration frequency	0.0 to 400.0	0.0	No	Hz	107A
A295	2nd 2-step acceleration frequency					151F
A096	2-step deceleration frequency	0.0 to 400.0	0.0	No	Hz	107C
A296	2nd 2-step deceleration frequency					1521
A097	Acceleration pattern selection	00: Line	00	No	-	107D
A098	Deceleration pattern setting	01: S-shape curve				107E
A101	OI start frequency	0.0 to 400.0	0.0	No	Hz	1080
A102	OI end frequency					1082
A103	OI start ratio	0. to 100.	0.	No	%	1083
A104	OI end ratio		100.			1084
A105	OI start selection	00: Use OI start frequency [A101] 01: 0 Hz start	01	No	-	1085
A141	Operation frequency input A setting	00: Digital operator (F001) 01: Digital operator (FREQ adjuster)	01	No	-	108E
A142	Operation frequency input B setting	02: Input O 03: Input OI 04: RS485 communication	02			108F
A143	Operator selection	00: Addition (A + B) 01: Subtraction (A - B) 03: Multiplication (A x B)	00	No	-	1090
A145	Frequency addition amount	0.0 to 400.0	0.0	Yes	Hz	1091
A146	Frequency addition direction	00: Adds A145 value to output frequency 01: Subtract A145 value from output frequency	00	No	-	1093
A151	VR start frequency	0.0 to 400.0	0.0	No	Hz	1095
A152	VR end frequency					1097
A153	VR start ratio	0. to 100.	0.	No	%	1098
A154	VR end ratio		100.			1099
A155	VR start selection	00: Use VR start frequency [A151] 01: 0 Hz start	01	No	-	109A

4.3 Parameter group B

Parameter No.	Function name	Monitoring or data range (digital operator)	Default setting	Changes during operation	Unit	Modbus address (hex)
b001	Retry selection	00: Alarm 01: 0 Hz start 02: Frequency matching start 03: Trip after frequency matching deceleration stop	00	No	-	10A5
b002	Allowable momentary power interruption time	0.3 to 25.0	1.0	No	s	10A6
b003	Retry wait time	0.3 to 100.0	1.0	No	s	10A7
b004	Momentary power interruption/undervoltage trip during stop selection	00: Disabled 01: Enabled	00	No	-	10A8
b005	Momentary power interruption retry time selection	00: 16 times 01: No limit	00	No	-	10A9
b011	Starting frequency at active frequency matching restart	00: Frequency at interruption 01: Max. frequency 02: Set frequency	00	No	-	1170
b012	Electronic thermal level	0.2 x Rated current to 1.0 x Rated current	Rated current	No	A	10AD
b212	2nd electronic thermal level					1527
b013	Electronic thermal characteristics selection	00: Reduced torque characteristics 1	00	No	-	10AE
b213	2nd electronic thermal characteristics selection	01: Constant torque characteristics 02: Reduced torque characteristics 2				1528
b021	Overload limit selection	00: Disabled	01	No	-	10B5
b221	2nd overload limit selection	01: Enabled in acceleration/constant speed operation 02: Enabled in constant speed operation				1529
b022	Overload limit level	0.1 x Rated current to 1.5 x Rated current	1.5 x Rated current	No	A	10B6
b222	2nd overload limit level					152A
b023	Overload limit parameter	0.1 to 3000.0	1.0	No	s	10B7
b223	2nd overload limit parameter					152B
b028	Overload limit source selection	00: b022, b222 set values	00	No	-	10BB
b228	2nd overload limit source selection	01: Input terminal O				152C
b029	Deceleration rate constant at active frequency matching restart level	0.1 to 3000.0	0.5	No	s	1171
b030	Active frequency matching restart level	0.2 x Rated current to 2.0 x Rated current	Rated current	No	A	1172

PARAMETER LIST

Parameter No.	Function name	Monitoring or data range (digital operator)	Default setting	Changes during operation	Unit	Modbus address (hex)
b031	Soft lock selection	00: Data other than b031 cannot be changed when terminal SFT is ON 01: Data other than b031 and the specified frequency parameter cannot be changed when terminal SFT is ON 02: Data other than b031 cannot be changed 03: Data other than b031 and the specified frequency parameter cannot be changed 10: Data other than parameters changeable during operation cannot be changed	01	No	–	10BC
b050	Selection of non-stop function at momentary power interruption	00: Disabled 01: Enabled (Stop) 02: Enabled (Restart)	00	No	–	10C9
b051	Starting voltage of non-stop function at momentary power interruption	0.0 to 1000.	0.0	No	V	10CA
b052	Stop deceleration level of non-stop function at momentary power interruption					10CB
b053	Deceleration time of non-stop function at momentary power interruption	0.01 to 3000	1.0	No	s	10CC
b054	Deceleration starting width of non-stop function at momentary power interruption	0.0 to 10.0	0.0	No	Hz	10CE
b055	Overvoltage protection proportional gain during deceleration	0.2 to 5.0	0.2	Yes	–	1173
b056	Overvoltage protection integral time during deceleration	0.0 to 150.0	0.2	Yes	s	1174
b080	AM adjustment	0. to 255. (Shared with C086 for AM offset adjustment)	100.	Yes	–	10CF
b082	Starting frequency	0.5 to 9.99	1.5	No	Hz	10D1
b083	Carrier frequency	2.0 to 12.0	3.0	No	kHz	10D2
b084	Initialization selection	00: Clears the trip monitor 01: Initializes data 02: Clears the trip monitor and initializes data	00	No	–	10D3
b085	Initialization parameter selection	00 (Do not change)	00	No	–	10D4
b086	Frequency conversion coefficient	0.1 to 99.9	1.0	Yes	–	10D5
b087	STOP key selection	00: Enabled 01: Disabled	00	No	–	10D6
b088	Free-run stop selection	00: 0 Hz start 01: Active frequency matching restart	00	No	–	10D7
b089	Monitor display selection	01: Output frequency monitor 02: Output current monitor 03: Rotation direction monitor 04: PID feedback value monitor 05: Multi-function input monitor 06: Multi-function output monitor 07: Frequency conversion monitor	01	Yes	–	10D8
b091	Stop selection	00: Decel-Stop 01: Free-RUN	00	No	–	10DA
b092	Cooling fan control	00: Always ON 01: ON during RUN 02: Depends on the fin temperature	01	No	–	10DB
b130	Overvoltage LAD stop function	00: Disabled 01: Enabled	00	No	–	10F5
b131	Overvoltage LAD stop function level setting	200-V class: 330. to 395. 400-V class: 660. to 790.	380/760	Yes	V	10F6
b133	Overvoltage protection function selection during deceleration	00: Disabled 01: Enabled	00	No	–	1176
b134	Overvoltage protection level setting during deceleration	200-V class: 330. to 395. 400-V class: 660. to 790.	380/760	No	V	1177
b140	Overcurrent suppression function	00: Disabled 01: Enabled	01	No	–	10F7
b150	Automatic carrier reduction	00: Disabled 01: Enabled	00	No	–	10F8
b151	Ready function selection	00: Disabled 01: Enabled	00	No	–	10F9

PARAMETER LIST

4.4 Parameter group C

Parameter No.	Function name	Monitoring or data range (digital operator)	Default setting	Changes during operation	Unit	Modbus address (hex)
C001	Multi-function input 1 selection	00: FW (forward) 01: RV (reverse) 02: CF1 (multi-step speed setting binary 1)	00	No	–	1103
C201	2nd multi-function input 1 selection	03: CF2 (multi-step speed setting binary 2) 04: CF3 (multi-step speed setting binary 3) 05: CF4 (multi-step speed setting binary 4) 06: JG (jogging)	00			1532
C002	Multi-function input 2 selection	07: DB (external DC injection braking) 08: SET (2nd control) 09: 2CH (2-step acceleration/deceleration)	01			1104
C202	2nd multi-function input 2 selection	11: FRS (free-run stop) 12: EXT (external trip) 13: USP (USP function) 15: SFT (soft lock)	01			1533
C003	Multi-function input 3 selection	16: AT (analog input switching) 18: RS (reset) 19: PTC (thermistor input)	18			1105
C203	2nd multi-function input 3 selection	20: STA (3-wire start) 21: STP (3-wire stop) 22: F/R (3-wire forward/reverse) 23: PID (PID enabled/disabled)	18			1534
C004	Multi-function input 4 selection	24: PIDC (PID integral reset) 27: UP (UP/DWN function accelerated) 28: DWN (UP/DWN function decelerated)	12			1106
C204	2nd multi-function input 4 selection	29: UDC (UP/DWN function data clear) 31: OPE (forced operator) 50: ADD (frequency addition) 51: F-TM (forced terminal block) 52: RDY (ready function) 53: SP-SET (special 2nd function) 64: EMR (emergency shutoff ^{*1})	12			1535
C005	Multi-function input 5 selection	255: No function	02			1107
C205	2nd multi-function input 5 selection		02			1536
		*1. The EMR is set forcibly with switch S8, not with parameters.				
C011	Multi-function input 1 operation selection	00: NO	00	No	–	110B
C012	Multi-function input 2 operation selection	01: NC				110C
C013	Multi-function input 3 operation selection					110D
C014	Multi-function input 4 operation selection					110E
C015	Multi-function input 5 operation selection					110F
C021	Multi-function output terminal 11 selection	00: RUN (signal during RUN) 01: FA1 (constant speed arrival signal) 02: FA2 (over set frequency arrival signal) 03: OL (overload warning) 04: OD (excessive PID deviation) 05: AL (alarm output)	00	No	–	1114
C026	Relay output (AL2, AL1) function selection	06: Dc (disconnection detection) 07: FBV (PID FB status output) 08: NDc (network error) 09: LOG (logic operation output) 10: ODc (do not use) 43: LOC (light load detection signal)	05			1119
C028	AM selection	00: Output frequency 01: Output current	00	No	–	111B
C031	Multi-function output terminal 11 contact selection	00: NO contact at AL2, NC contact at AL1 01: NC contact at AL2, NO contact at AL1	00	No	–	111D
C036	Relay output (AL2, AL1) contact selection		01			1122
C038	Light load signal output mode	00: Enabled during acceleration/deceleration/constant speed 01: Enabled only during constant speed	01	No	–	1178
C039	Light load detection level	0.0 to 2.0 x Rated current (0.0 setting: function disable)	Rated current	No	–	1179
C041	Overload warning level	0.0: Does not operate	Rated current	No	A	1124
C241	2nd overload warning level	0.1 x Rated current to 2.0 x Rated current				153A
C042	Arrival frequency during acceleration	0.0 to 400.0	0.0	No	Hz	1126
C043	Arrival frequency during deceleration					1128
C044	PID deviation excessive level	0.0 to 100.0	3.0	No	%	1129
C052	PID FB upper limit	0.0 to 100.0	100.0	No	%	112E
C053	PID FB lower limit		0.0			112F
C070	Operator/Modbus selection	02: Digital Operator 03: Modbus	02	No	–	1137
C071	Communication speed selection (Baud rate selection)	04: 4800 bps 05: 9600 bps 06: 19200 bps	04	No	–	1137
C072	Communication station No. selection	1. to 32.	1.	No	–	1139

PARAMETER LIST

Parameter No.	Function name	Monitoring or data range (digital operator)	Default setting	Changes during operation	Unit	Modbus address (hex)
C074	Communication parity selection	00: No parity 01: Even 02: Odd	00	No	–	113B
C075	Communication stop bit selection	1: 1-bit 2: 2-bit	1	No	–	113C
C076	Communication error selection	00: Trip 01: Trip after deceleration stop 02: Ignore 03: Free run 04: Deceleration Stop	02	No	–	113D
C077	Communication error timeout	0.00 to 99.99	0.00	No	s	113E
C078	Communication wait time	0. to 1000.	0.	No	ms	113F
C081	O adjustment	0.0 to 200.0	100.0	Yes	%	1141
C082	OI adjustment					1142
C086	AM offset adjustment	0.0 to 10.0	0.0	Yes	V	1145
C091	Not used	Use "00" (Do not change)	00	–	–	–
C101	UP/DWN selection	00: Do not store the frequency data 01: Store the frequency data	00	No	–	1149
C102	Reset selection	00: Trip reset at rising edge of RS input 01: Trip reset at falling edge of RS input 02: Enabled only during trip (Reset at rising edge of RS input)	00	No	–	114A
C141	Logic operation function A input	00: RUN (signal during RUN) 01: FA1 (constant speed arrival signal) 02: FA2 (over set frequency arrival signal) 03: OL (overload warning) 04: OD (excessive PID deviation)	00	No	–	1150
C142	Logic operation function B input	05: AL (alarm output) 06: Dc (disconnection detected) 07: FBV (PID FB status output) 08: NDc (network error) 10: ODc (do not use) 43: LOC (light load detection signal)	01			1151
C143	Logic operator selection	00: AND 01: OR 02: XOR	00	No	–	1152
C144	Output terminal 11 ON delay	0.0 to 100.0	0.0	No	s	1153
C145	Output terminal 11 OFF delay					1154
C148	Relay output ON delay	0.0 to 100.0	0.0	No	s	1157
C149	Relay output OFF delay					1158

4.5 Parameter group H

Parameter No.	Function name	Monitoring or data range (digital operator)	Default setting	Changes during operation	Unit	Modbus address (hex)
H003	Motor capacity selection	200-V class: 0.2/0.4/0.75/1.5/2.2/3.7/5.5/7.5 400-V class: 0.4/0.75/1.5/2.2/3.7/5.5/7.5	Factory default	No	kW	1165
H203	2nd motor capacity selection					1541
H004	Motor pole number selection	2/4/6/8	4	No	Pole	1166
H204	2nd motor pole number selection					1542
H006	Stabilization parameter	0. to 255.	100	Yes	%	1168
H206	2nd stabilization parameter					1544

4.6 Parameter group F

Parameter No.	Function name	Monitoring or data range (digital operator)	Default setting	Changes during operation	Unit	Modbus address (hex)
F001	Output frequency setting/monitor	Starting frequency to 1st or 2nd max. frequency	–	Yes	Hz	–
F002	Acceleration time 1	0.01 to 3000.	10.0	Yes	s	1014 (high)
F202	2nd acceleration time 1					1015 (low)
						1501 (high)
1502 (low)						
F003	Deceleration time 1	0.01 to 3000.	10.0	Yes	s	1016 (high)
F203	2nd deceleration time 1					1017 (low)
						1503 (high)
1504 (low)						
F004	Operator rotation direction selection	00: Forward 01: Reverse	00	No	–	1018

OMRON EUROPE B.V. Wegalaan 67-69, NL-2132 JD, Hoofddorp, The Netherlands.
Tel: +31 (0) 23 568 13 00 Fax: +31 (0) 23 568 13 88 industrial.omron.eu

Austria

Tel: +43 (0) 2236 377 800
industrial.omron.at

Belgium

Tel: +32 (0) 2 466 24 80
industrial.omron.be

Czech Republic

Tel: +420 234 602 602
industrial.omron.cz

Denmark

Tel: +45 43 44 00 11
industrial.omron.dk

Finland

Tel: +358 (0) 207 464 200
industrial.omron.fi

France

Tel: +33 (0) 1 56 63 70 00
industrial.omron.fr

Germany

Tel: +49 (0) 2173 6800 0
industrial.omron.de

Hungary

Tel: +36 (0) 1 399 30 50
industrial.omron.hu

Italy

Tel: +39 02 326 81
industrial.omron.it

South Africa

Tel: +27 (0) 11 579 2600
industrial.omron.eu

Netherlands

Tel: +31 (0) 23 568 11 00
industrial.omron.nl

Norway

Tel: +47 (0) 22 65 75 00
industrial.omron.no

Poland

Tel: +48 22 458 66 6
industrial.omron.com.pl

Portugal

Tel: +351 21 942 94 00
industrial.omron.pt

Russia

Tel: +7 495 648 94 50
industrial.omron.ru

Spain

Tel: +34 902 100 221
industrial.omron.es

Sweden

Tel: +46 (0) 8 632 35 00
industrial.omron.se

Switzerland

Tel: +41 41 748 13 13
industrial.omron.ch

Turkey

Tel: +90 212 467 30 00
industrial.omron.com.tr

United Kingdom

Tel: +44 (0) 870 752 08 61
industrial.omron.co.uk

Note: Specifications subject to change without notice.
Cat. No. I128E-EN-01

OMRON